



Independent Protection Co., Inc.

1607 South Main St.

Goshen, IN. 46526

574.533.4116 or 1.800.860.8388

Fax: 574.534.3719

info@ipclp.com www.ipclp.com

UL Listing No. E10913

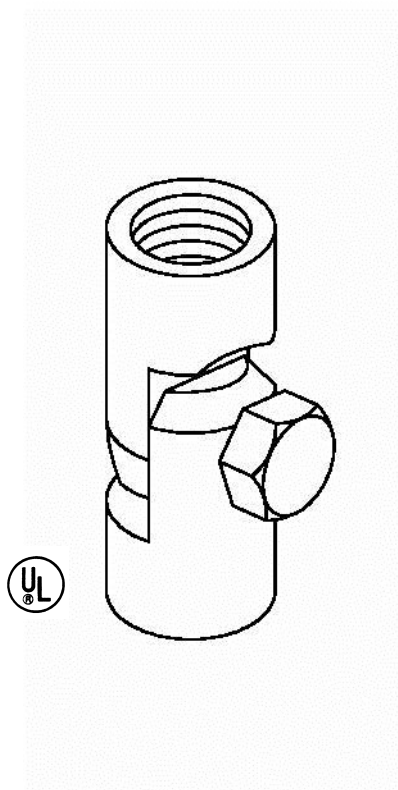

MAADJ58FT58FB

Adjustable Adaptors Female Top to Female Bottom

Machined aluminum

5/8" female top

5/8" female bottom

Wt. .18 lbs. each.

Note: Sizing for 5/8" diameter fixed and adjustable adaptors is as follows:

Adapter Top: Female threads for air terminal is 5/8" - 11 UNC.

Adapter Bottom: Female threads for bases is 5/8" - 14 UNC.