



Independent Protection Co., Inc.

1607 South Main St.

Goshen, IN. 46526

574.533.4116 or 1.800.860.8388

Fax: 574.534.3719

info@ipclp.com www.ipclp.com

UL Listing No. E10913

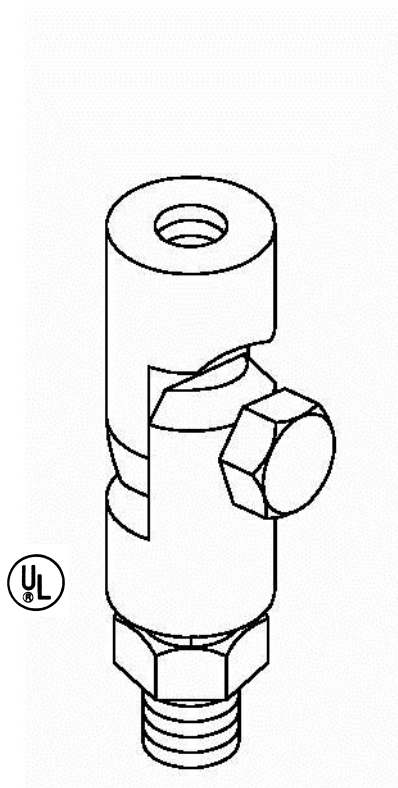

MADJ38FT12MB

**Adjustable Adaptors Female Top
to Male Bottom**

Machined brass
3/8" female top
1/2" male bottom
Wt. .40 lbs. each.