



Independent Protection Co., Inc.

1607 South Main St.

Goshen, IN. 46526

574.533.4116 or 1.800.860.8388

Fax: 574.534.3719

info@ipclp.com www.ipclp.com

UL Listing No. E10913

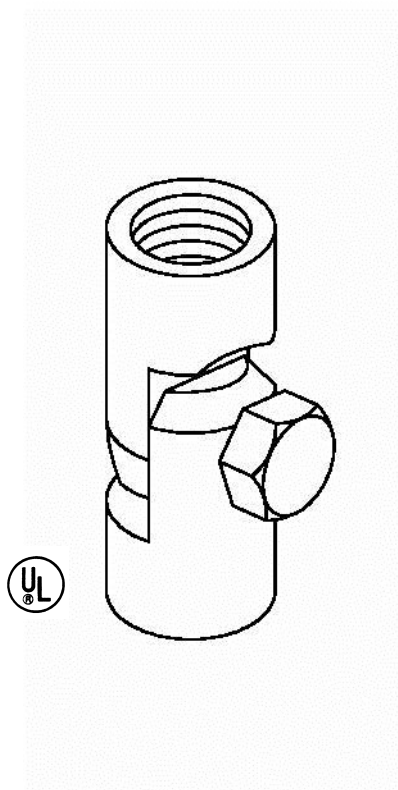

MADJ58FT58FB

Adjustable Adaptors Female Top to Female Bottom

Machined brass
5/8" female top
5/8" female bottom
Wt. .42 lbs. each.

Note: Sizing for 5/8" diameter fixed and adjustable adapters is as follows:
Adapter Top: Female threads for air terminal is 5/8" - 11 UNC.
Adapter Bottom: Female threads for bases is 5/8" - 14 UNC.